

Scanning distance
 1 ... 15/30 mm
Photoelectric proximity switch

- A focused, laser-like light spot makes the most precise detection jobs possible
- Insensitive to interference from critical backgrounds
- Sturdy housing with metal sleeves for M3 bolts

Dimensional drawing

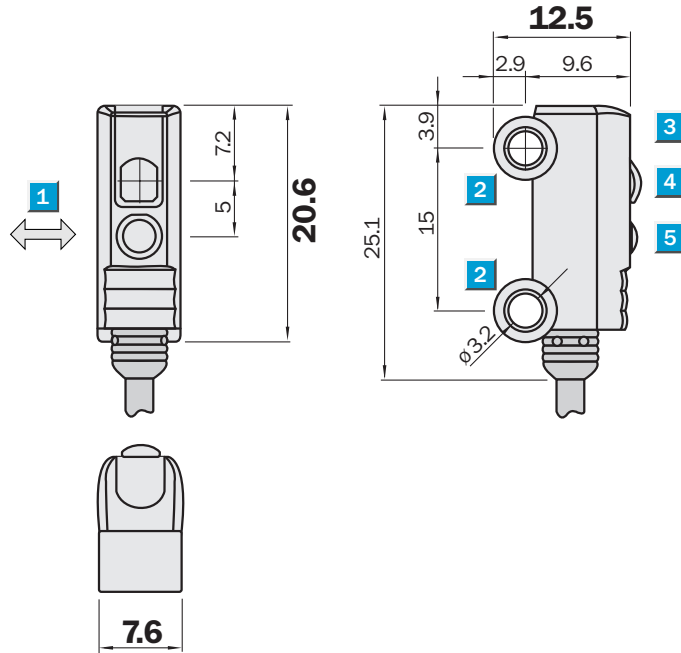

- 1 Standard direction of material being scanned
- 2 Mounting hole \varnothing 3.2 mm
- 3 LED signal strength indicator
- 4 Optical axis, receiver
- 5 Optical axis, sender



Connection type

WT2S-F131	WT2S-F211	WT2S-P411
WT2S-N111	WT2S-P211	WT2S-P431
WT2S-N131	WT2S-P231	
WT2S-P111		
WT2S-P131		

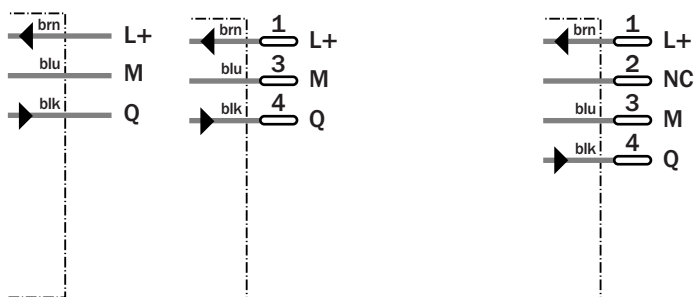
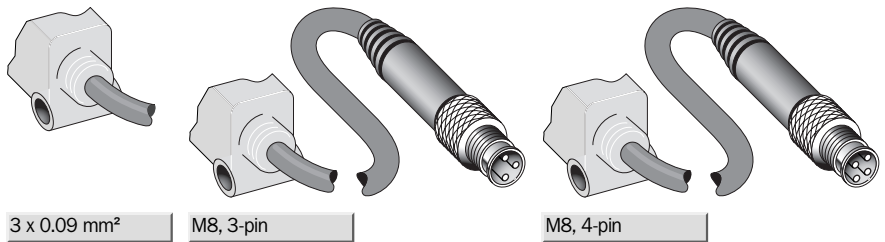

See chapter Accessories
 Connector, M8, 3-pin
 Connector, M8, 4-pin
 Mounting systems

Technical specifications		WT2S-	F131	F211	N111	N131	P111	P131	P211	P231	P411	P431
Scanning distance typ. max.	1 ... 30 mm ¹⁾											
	1 ... 15 mm ¹⁾											
Light source, light type	Pin Point LED, Red light ²⁾											
Light spot diameter	Approx. 1.0 mm at 15 mm distance											
	Approx. 1.2 mm at 8 mm distance											
	Approx. 2.5 mm at 15 mm distance											
Supply voltage V _s	DC 10 ... 30 V ³⁾											
Ripple	< 5 V _{pp} ⁴⁾											
Power consumption	< 20 mA ⁵⁾											
Switching outputs	PNP, Q											
	NPN, Q											
Switching mode	Dark-switching											
	Light-switching											
Output current I _a max	< 50 mA											
Response time	< 0.6 ms ⁶⁾											
Switching frequency	800 Hz ⁷⁾											
Connection type	Cable, PVC, 2 m ⁸⁾											
	Cable with plug, M8, 3-pin, PVC, 200 mm ⁸⁾											
	Cable with plug, M8, 4-pin, PVC, 200 mm ⁸⁾											
VDE protection class	◆											
Circuit protection	V _s connections reverse-polarity protected / Output Q and Q not short-circuit protected / Interference suppression											
Enclosure rating	IP 67, IP 69K											
Ambient temperature operation	-20 °C ... +50 °C											
Ambient temperature storage	-40 °C ... +75 °C											
Weight	18 g											
	20 g											
Housing material	ABS, PMMA											

¹⁾ Object with 90% remission (based on standard white to DIN 5033)

at T_a = +25 °C

³⁾ Limit values

⁴⁾ may not exceed or fall short of

V_s tolerances

⁵⁾ without load

⁶⁾ Signal transit time with resistive load

⁷⁾ with light/dark ratio 1:1

⁸⁾ do not bend below 0 °C

Scanning distance and light spot diameter

Scanning distance 1 ... 30 mm

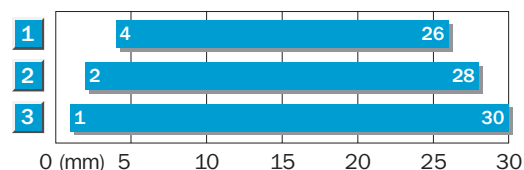

- 1 Scanning distance on black, 6 % remission
- 2 Scanning distance on grey, 18 % remission
- 3 Scanning distance on white, 90 % remission

Scanning distance 1 ... 15 mm

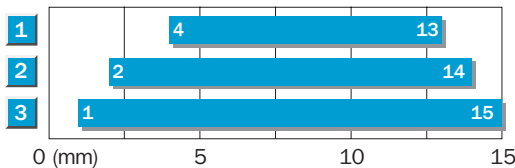

- 1 Scanning distance on black, 6 % remission
- 2 Scanning distance on grey, 18 % remission
- 3 Scanning distance on white, 90 % remission

Light spot diameter at SD 1 ... 30 mm

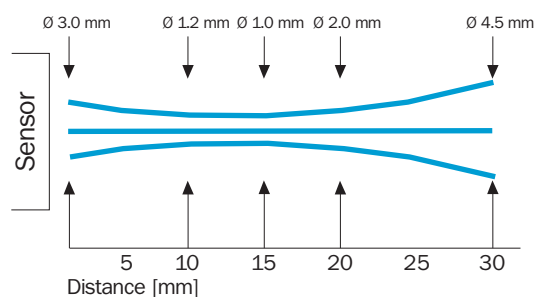

Light spot diameter at SD 1 ... 15 mm

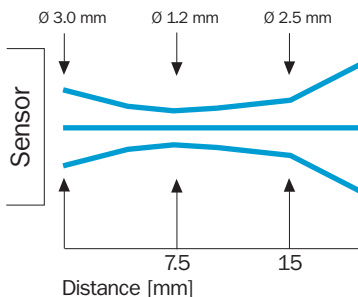

Ordering information

Type	Order no.
WT2S-F131	1 025 682
WT2S-F211	1 024 171
WT2S-N111	1 022 662
WT2S-N131	1 022 663
WT2S-P111	1 022 660
WT2S-P131	1 022 661
WT2S-P211	1 022 658
WT2S-P231	1 022 659
WT2S-P411	1 023 631
WT2S-P431	1 023 632

Scanning distance
1 ... 55 mm
Photoelectric proximity switch

- Precise, small light spot
- Extremely good size/performance ratio
- Sturdy housing with metal sleeves for M3 bolts

Dimensional drawing

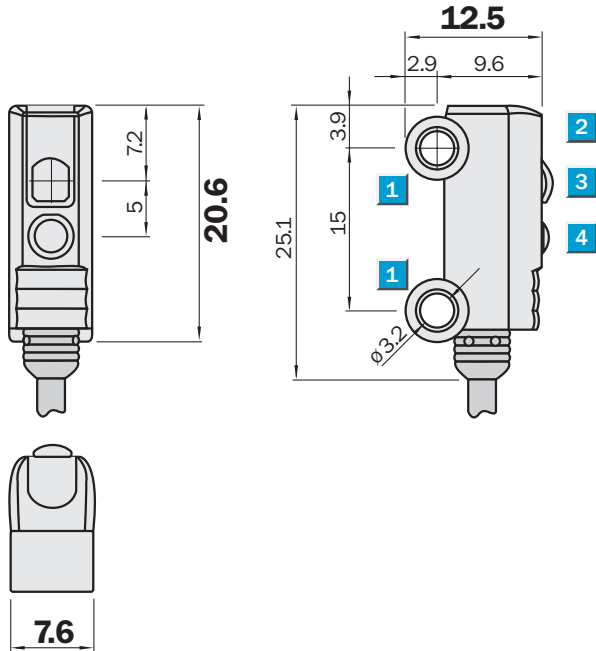

- 1 Mounting hole \varnothing 3.2 mm
- 2 LED signal strength indicator
- 3 Optical axis, receiver
- 4 Optical axis, sender



Connection type

WT2S-N161	WT2S-P261	WT2S-P461
WT2S-P161		

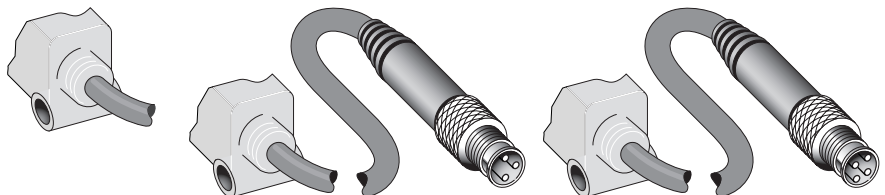

3 x 0.09 mm²

M8, 3-pin

M8, 4-pin

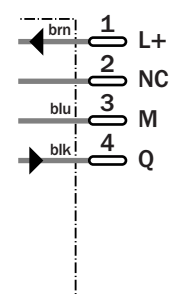
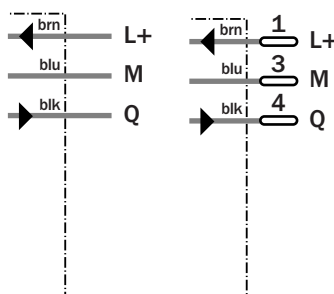

See chapter Accessories

- Connector, M8, 3-pin
- Connector, M8, 4-pin
- Mounting systems

Technical specifications		WT2S-	N161	P161	P261	P461						
Scanning distance typ. max.	1 ... 55 mm ¹⁾											
Light source, light type	Pin Point LED, Red light ²⁾											
Light spot diameter	Approx. 3.5 mm at 50 mm distance											
Supply voltage V _s	DC 10 ... 30 V ³⁾											
Ripple	< 5 V _{pp} ⁴⁾											
Power consumption	< 20 mA ⁵⁾											
Switching outputs	NPN, Q											
	PNP, Q											
Switching mode	Light-switching											
Output current I _a max	< 50 mA											
Response time	< 0.6 ms ⁶⁾											
Switching frequency	800 Hz ⁷⁾											
Connection type	Cable, PVC, 2 m ⁸⁾											
	Cable with plug, M8, 3-pin, PVC, 200 mm ⁸⁾											
	Cable with plug, M8, 4-pin, PVC, 200 mm ⁸⁾											
VDE protection class	⊖											
Circuit protection	V _s connections reverse-polarity protected / Output Q and Q not short-circuit protected / Interference suppression											
Enclosure rating	IP 67, IP 69K											
Ambient temperature operation	-20 °C ... +50 °C											
Ambient temperature storage	-40 °C ... +75 °C											
Weight	18 g											
	20 g											
Housing material	ABS, PMMA											

¹⁾ Object with 90% remission (based on standard white to DIN 5033)
²⁾ Average service life 75,000 h

at T_a = +25 °C
³⁾ Limit values
⁴⁾ may not exceed or fall short of

V_s tolerances
⁵⁾ without load
⁶⁾ Signal transit time with resistive load

⁷⁾ with light/dark ratio 1:1
⁸⁾ do not bend below 0 °C

Scanning distance and light spot diameter

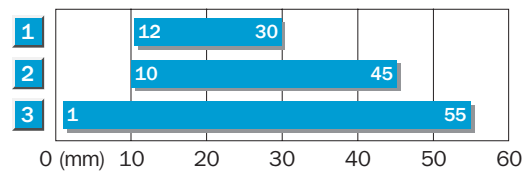

- 1 Scanning distance on black, 6 % remission
- 2 Scanning distance on grey, 18 % remission
- 3 Scanning distance on white, 90 % remission

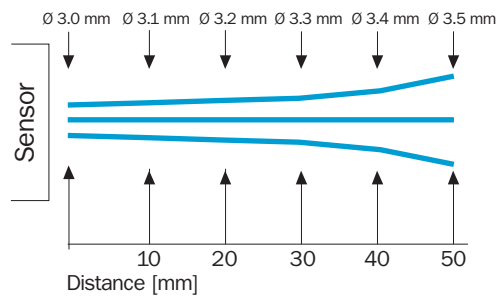

Ordering information

Type	Order no.
WT2S-N161	1 022 665
WT2S-P161	1 022 664
WT2S-P261	1 023 640
WT2S-P461	1 023 641

Scanning distance
1/2 ... 9/18 mm

Photoelectric proximity switch

- Detection of transparent and reflective objects
- Robust housing with metal-reinforced fixing holes
- Simple adjustment. Connect, align - ready
- No external amplifier required. Can be directly connected to the machine control system

Dimensional drawing

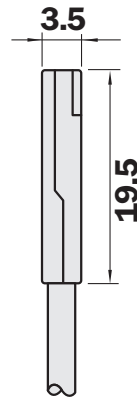
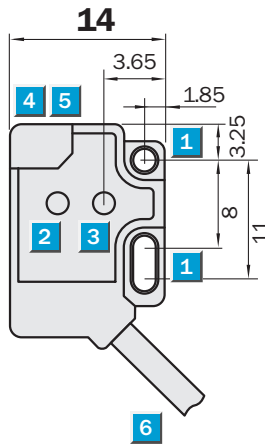

- 1 Mounting hole \varnothing 2.1 mm
- 2 Optical axis, sender
- 3 Optical axis, receiver
- 4 LED indicator orange; output active
- 5 LED indicator green; strength indicator
- 6 Connection



Connection type

WT2F-N140
WT2F-N170
WT2F-P140
WT2F-P170

WT2F-P240
WT2F-P270

WT2F-P440
WT2F-P470

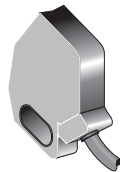

3 x 0.09 mm²

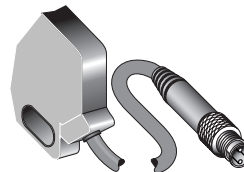
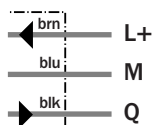

M8, 3-pin

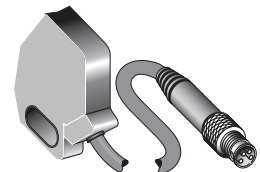
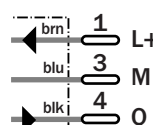

M8, 4-pin

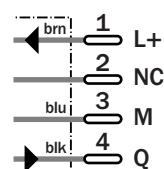

See chapter Accessories

Connector, M8, 3-pin

Connector, M8, 4-pin

Technical specifications		WT2F-	N140	N170	P140	P170	P240	P270	P440	P470
Scanning distance typ. max.	2 ... 18 mm ¹⁾									
	1 ... 9 mm ¹⁾									
Operating distance	2 ... 15 mm ¹⁾									
	1 ... 8 mm ¹⁾									
Light source, light type	LED, Red light, 660 nm ²⁾									
Supply voltage V_s	DC 12 ... 24 V ³⁾									
Ripple	≤ 5 V _{pp} ⁴⁾									
Power consumption	≤ 20 mA ⁵⁾									
Switching outputs	NPN: open collector: Q									
	PNP: open collector: Q									
Switching mode	Light-switching									
Signal voltage PNP HIGH / LOW	V _s - 1.8 V / approx. 0 V									
Signal voltage NPN HIGH / LOW	Approx. V _s / < 1.8 V									
Output current I _a max	≤ 50 mA									
Response time	≤ 0.5 ms ⁶⁾									
Switching frequency	1,000 Hz ⁷⁾									
Connection type	Cable, PVC, 2 m ⁸⁾									
	Cable with plug, M8, 3-pin, PVC, 200 mm ⁸⁾									
	Cable with plug, M8, 4-pin, PVC, 200 mm ⁸⁾									
VDE protection class	◆									
Circuit protection	V _s connections reverse-polarity protected / In-/outputs short-circuit protected / Outputs overcurrent and short-circuit protected									
Enclosure rating	IP 67									
Ambient temperature operation	-20 °C ... +50 °C									
Ambient temperature storage	-40 °C ... +75 °C									
Weight	Approx. 20 g									
Housing material	PC / PBT, PC									

¹⁾ Object with 90% remission (based on standard white to DIN 5033)

²⁾ Average service life 100,000 h

at T_a = +25°C

³⁾ ± 10%

⁴⁾ may not exceed or fall short of

V_s tolerances

⁵⁾ without load

⁶⁾ Signal transit time with resistive load

⁷⁾ with light/dark ratio 1:1

⁸⁾ do not bend below 0 °C

Scanning distance and function reserve

Scanning distance 2 ... 18 mm

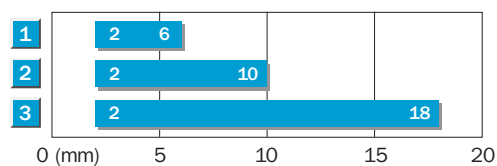

- 1 Scanning distance on black, 6 % remission
- 2 Scanning distance on grey, 18 % remission
- 3 Scanning distance on white, 90 % remission

Scanning distance 1 ... 9 mm

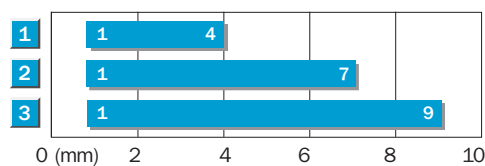

- 1 Scanning distance on black, 6 % remission
- 2 Scanning distance on grey, 18 % remission
- 3 Scanning distance on white, 90 % remission

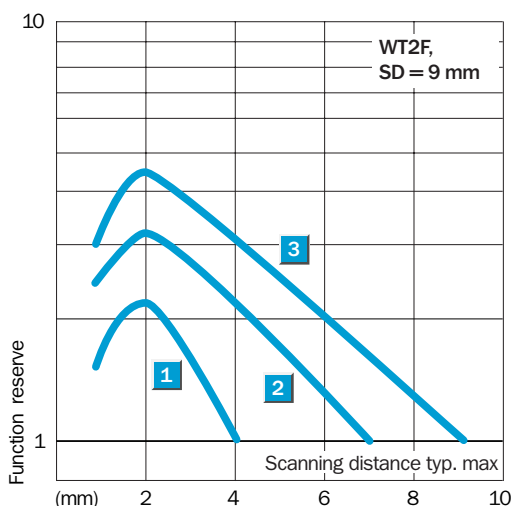
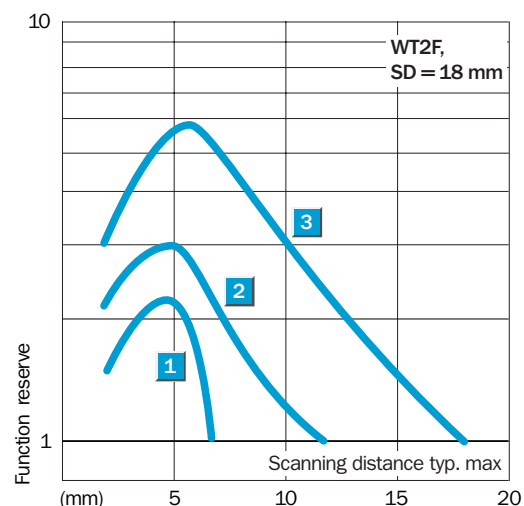

Ordering information

Type	Order no.
WT2F-N140	6 030 583
WT2F-N170	6 030 587
WT2F-P140	6 030 584
WT2F-P170	6 030 588
WT2F-P240	6 030 585
WT2F-P270	6 030 589
WT2F-P440	6 030 586
WT2F-P470	6 030 590

Scanning distance
2/4 ... 34/115 mm

Photoelectric proximity switch

- Robust housing with metal-reinforced fixing holes
- Simple adjustment.
Connect, align - ready
- No external amplifier required.
Can be directly connected to the machine control system

Dimensional drawing

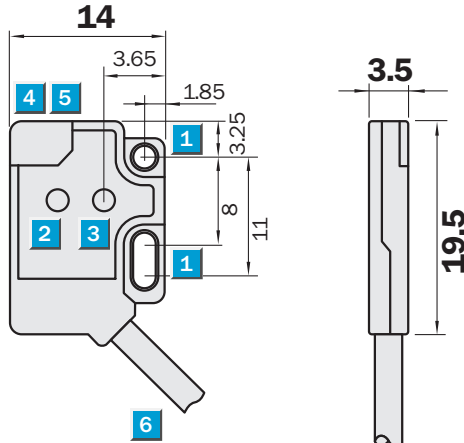

- 1 Mounting hole \varnothing 2.1 mm
- 2 Optical axis, sender
- 3 Optical axis, receiver
- 4 LED indicator orange; output active
- 5 LED indicator green; strength indicator
- 6 Connection



See chapter Accessories

Connector, M8, 3-pin

Connector, M8, 4-pin

Connection type

- WT2F-N150
- WT2F-N180
- WT2F-P150
- WT2F-P180

- WT2F-P250
- WT2F-P280

- WT2F-P450
- WT2F-P480

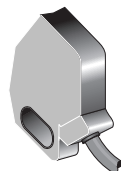

3 x 0.09 mm²

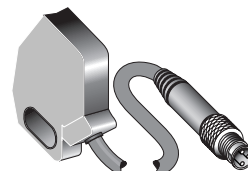

M8, 3-pin

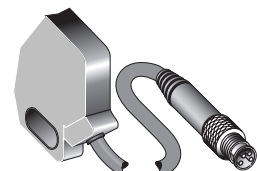
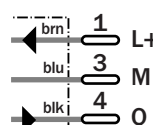

M8, 4-pin

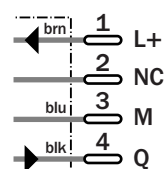

Technical specifications		WT2F-	N150	N180	P150	P180	P250	P280	P450	P480
Scanning distance typ. max.	2 ... 34 mm ¹⁾									
	4 ... 115 mm ¹⁾									
Operating distance	2 ... 30 mm ¹⁾									
	4 ... 100 mm ¹⁾									
Light source, light type	LED, Red light, 660 nm ²⁾									
Supply voltage V_s	DC 12 ... 24 V ³⁾									
Ripple	≤ 5 V _{pp} ⁴⁾									
Power consumption	≤ 20 mA ⁵⁾									
Switching outputs	NPN: open collector: Q									
	PNP: open collector: Q									
Switching mode	Light-switching									
Signal voltage PNP HIGH / LOW	V _s - 1.8 V / approx. 0 V									
Signal voltage NPN HIGH / LOW	Approx. V _s / < 1.8 V									
Output current I _a max	≤ 50 mA									
Response time	≤ 0.5 ms ⁶⁾									
Switching frequency	1,000 Hz ⁷⁾									
Connection type	Cable, PVC, 2 m ⁸⁾									
	Cable with plug, M8, 3-pin, PVC, 200 mm ⁸⁾									
	Cable with plug, M8, 4-pin, PVC, 200 mm ⁸⁾									
VDE protection class	◆									
Circuit protection	V _s connections reverse-polarity protected / In-/outputs short-circuit protected / Outputs overcurrent and short-circuit protected									
Enclosure rating	IP 67									
Ambient temperature operation	-20 °C ... +50 °C									
Ambient temperature storage	-40 °C ... +75 °C									
Weight	Approx. 20 g									
Housing material	PC / PBT, PC									

¹⁾ Object with 90% remission (based on standard white to DIN 5033)
²⁾ Average service life 100,000 h

at T_a = +25°C
³⁾ ± 10%
⁴⁾ may not exceed or fall short of

V_s tolerances
⁵⁾ without load
⁶⁾ Signal transit time with resistive load

⁷⁾ with light/dark ratio 1:1
⁸⁾ do not bend below 0 °C

Scanning distance and function reserve

Scanning distance 4 ... 115 mm

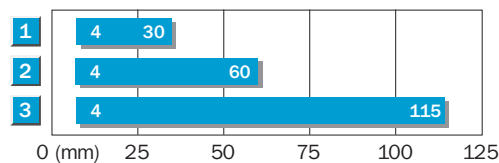

- 1 Scanning distance on black, 6 % remission
- 2 Scanning distance on grey, 18 % remission
- 3 Scanning distance on white, 90 % remission

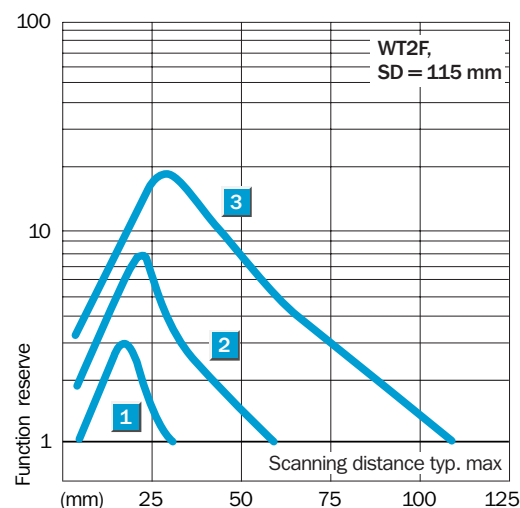

Scanning distance 2 ... 34 mm

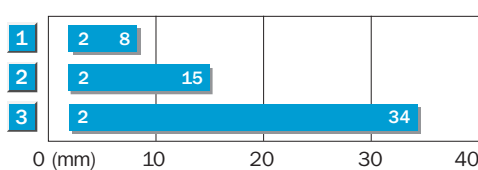

- 1 Scanning distance on black, 6 % remission
- 2 Scanning distance on grey, 18 % remission
- 3 Scanning distance on white, 90 % remission

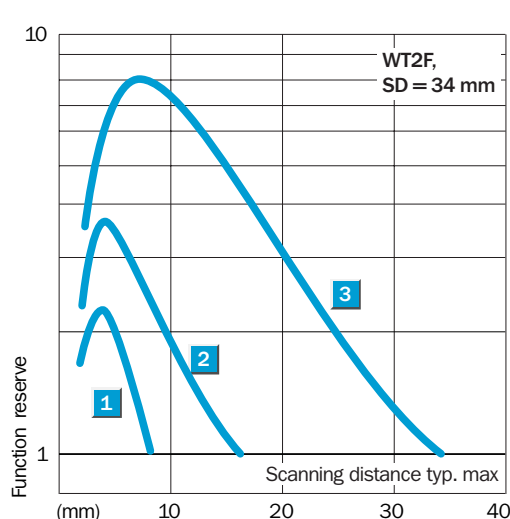

Ordering information

Type	Order no.
WT2F-N150	6 030 576
WT2F-N180	6 030 572
WT2F-P150	6 030 580
WT2F-P180	6 030 573
WT2F-P250	6 030 581
WT2F-P280	6 030 574
WT2F-P450	6 030 582
WT2F-P480	6 030 575

Photoelectric reflex switch, WL 2 Slim, red light

Scanning range
0.04 ... 0.8 m

Photoelectric reflex switch

- Extremely good size /performance ratio
- Easy and fast alignment using ball joint bracket
- Sturdy housing with metal sleeves for M3 bolts

Dimensional drawing

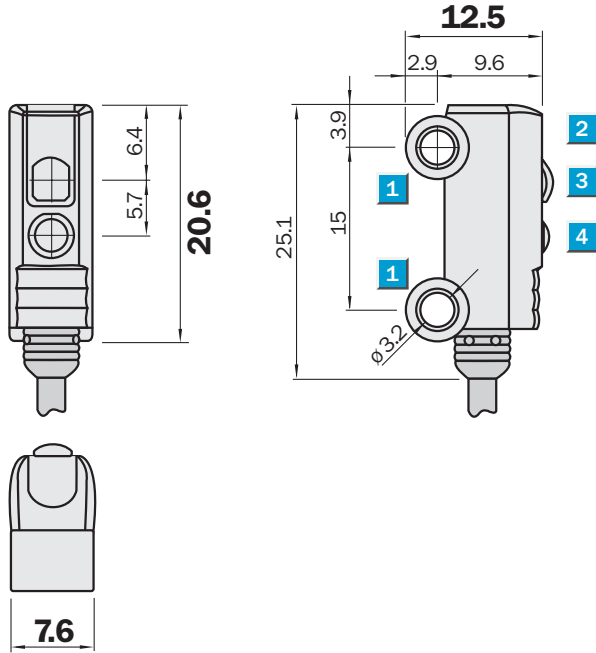

- 1** Mounting hole \varnothing 3.2 mm
- 2** LED signal strength indicator
- 3** Optical axis, receiver
- 4** Optical axis, sender



Connection type

WL2S-E111	WL2S-F211	WL2S-F411
WL2S-F111	WL2S-P211	
WL2S-N111		
WL2S-P111		

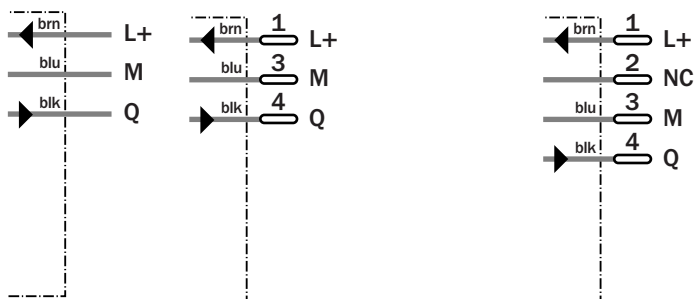
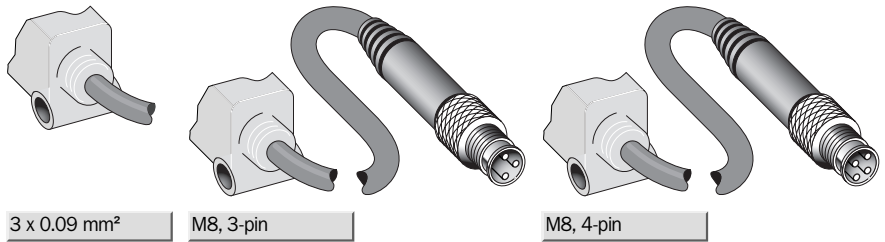

See chapter Accessories

Connector, M8, 3-pin
Connector, M8, 4-pin
Mounting systems
Reflectors

Technical specifications		WL2S-	E111	F111	F211	F411	N111	P111	P211			
Scanning range typ. max.	0.04 ... 0.8 m											
Scanning range, recommended	0.04 ... 0.4 m											
Relating to	Reflector PL 20 A											
Light source, light type	Pin Point LED, Red light ¹⁾											
Light spot diameter	10 mm at 100 mm distance											
Supply voltage V_s	DC 10 ... 30 V ²⁾											
Ripple	< 5 V _{pp} ³⁾											
Power consumption	< 20 mA ⁴⁾											
Switching outputs	NPN, Q											
	PNP, Q											
Switching mode	Dark-switching											
	Light-switching											
Output current I_a max	< 50 mA											
Response time	< 0.6 ms ⁵⁾											
Switching frequency	800 Hz ⁶⁾											
Connection type	Cable, PVC, 2 m ⁷⁾											
	Cable with plug, M8, 3-pin, PVC, 200 mm ⁷⁾											
	Cable with plug, M8, 4-pin, PVC, 2 m ⁷⁾											
VDE protection class	◆											
Circuit protection	V_s connections reverse-polarity protected / Output Q and Q not short-circuit protected / Interference suppression											
Enclosure rating	IP 67, IP69K											
Ambient temperature operation	-20 °C ... +50 °C											
Ambient temperature storage	-40 °C ... +75 °C											
Weight	18 g											
	20 g											
Housing material	ABS, PMMA											

¹⁾ Average service life 75,000 h at $T_a = +25^\circ\text{C}$
²⁾ Limit values of V_s tolerances
³⁾ may not exceed or fall short
⁴⁾ without load
⁵⁾ Signal transit time with resistive load
⁶⁾ with light/dark ratio 1:1
⁷⁾ do not bend below 0 °C

Scanning range and function reserve

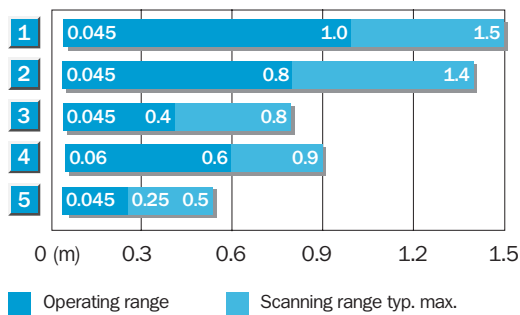

Reflector Type	Operating range
1 PL 40 A	0.045 ... 1.0 m
2 PL 30 A	0.045 ... 0.8 m
3 PL 20 A	0.045 ... 0.4 m
4 PL 22	0.06 ... 0.6 m
5 PL 10 F *)	0.045 ... 0.25 m

*) With reflector arrangement along the sensor axis

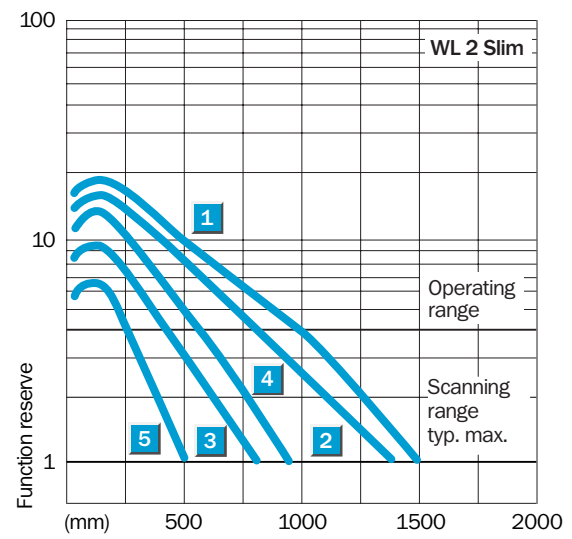

Ordering information	
Type	Order no.
WL2S-E111	1 022 667
WL2S-F111	1 022 666
WL2S-F211	1 023 868
WL2S-F411	1 023 644
WL2S-N111	1 023 870
WL2S-P111	1 023 869
WL2S-P211	1 024 249

Through-beam photoelectric switch, WS/WE 2 Slim, red light



Scanning range
0 ... 1.2 m

Through-beam photoelectric

- Excellent size/performance ratio
- Sturdy housing with metal sleeves for M3 bolts

Dimensional drawing

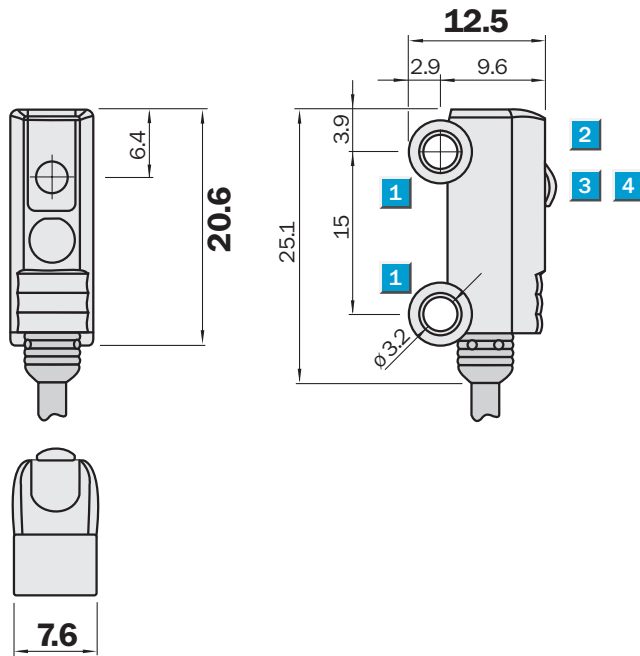

- 1 Mounting hole $\varnothing 3.2$ mm
- 2 LED signal strength indicator
- 3 Optical axis, receiver
- 4 Optical axis, sender

Connection type

WS/WE2S-E113

WS/WE2S-F113

WS/WE2S-F213

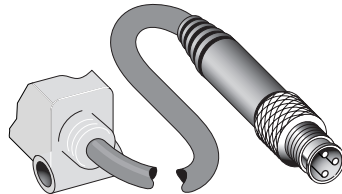
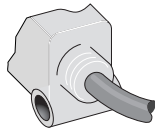

Sender 2 x 0.09 mm²

M8, 3-pin

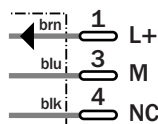
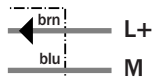

Receiver 3 x 0.09 mm²

M8, 3-pin

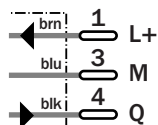
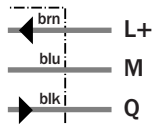

See chapter Accessories

Connector, M8, 3-pin

Mounting systems

Technical specifications		WS/WE2S-	E113	F113	F213							
Scanning range typ. max.	0 ... 1.2 m											
Scanning range, recommended	0 ... 1 m											
Light source, light type	Pin Point LED, Red light ¹⁾											
Light spot diameter	10 mm at 100 mm distance											
Supply voltage V_s	DC 10 ... 30 V ²⁾											
Ripple	< 5 V _{pp} ³⁾											
Power consumption, sender	< 20 mA ⁴⁾											
Power consumption, receiver	< 10 mA ⁴⁾											
Switching outputs	NPN, Q											
	PNP, Q											
Switching mode	Dark-switching											
Output current I_a max	< 50 mA											
Response time	< 2.5 ms ⁵⁾											
Switching frequency	200 Hz ⁶⁾											
Connection type	Cable, PVC, 2 m ⁷⁾											
	Cable with plug, M8, 3-pin, PVC, 200 mm ⁷⁾											
VDE protection class	◆											
Circuit protection	V_s connections reverse-polarity protected / Output Q and Q not short-circuit protected / Interference suppression											
Enclosure rating	IP 67, IP69K											
Ambient temperature operation	-20 °C ... +50 °C											
Ambient temperature storage	-40 °C ... +75 °C											
Weight	36 g											
	40 g											
Housing material	ABS, PMMA											

¹⁾ Average service life 75,000 h at $T_a = +25^\circ\text{C}$

²⁾ Limit values

³⁾ may not exceed or fall short of

V_s tolerances
⁴⁾ without load

⁵⁾ Signal transit time with resistive load

⁶⁾ with light/dark ratio 1:1

⁷⁾ do not bend below 0 °C

Scanning distance and function reserve

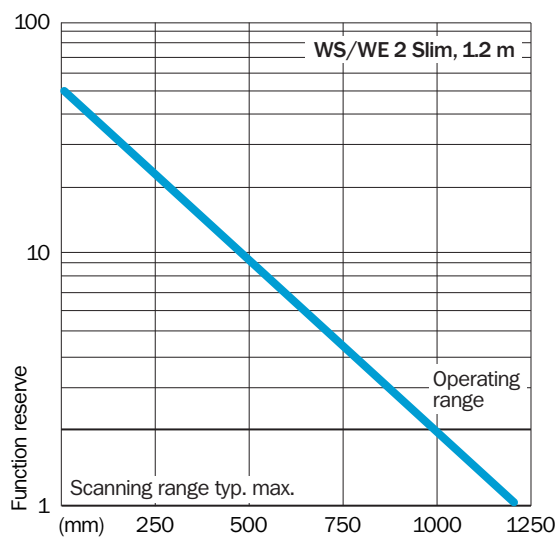
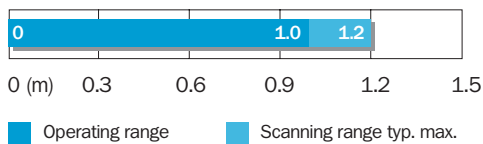

Ordering information

Type	Order no.
WS/WE2S-E113	1 022 669
WS/WE2S-F113	1 022 668
WS/WE2S-F213	1 023 650

Through-beam photoelectric switch, WS/WE 2 Flat, red light



Scanning range
0 ... 0.5 m

Through-beam photoelectric

- Robust housing with metal-reinforced fixing holes
- Simple adjustment.
Connect, align - ready
- No external amplifier required.
Can be directly connected to the machine control system

Dimensional drawing

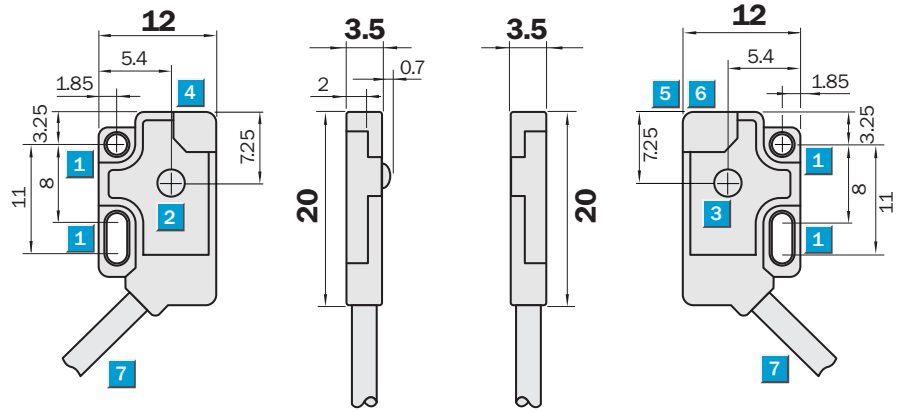

- 1 Mounting hole \varnothing 2.1 mm
- 2 Optical axis, sender
- 3 Optical axis, receiver
- 4 LED indicator green; supply voltage
- 5 LED indicator orange; output active
- 6 LED indicator green; strength indicator
- 7 Connection



Connection type

WS/WE2F-E110
WS/WE2F-F110
WS/WE2F-N110

WS/WE2F-F210
WS/WE2F-P210

WS/WE2F-F410

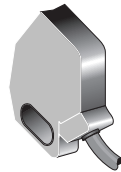

Sender 2 x 0.09 mm²

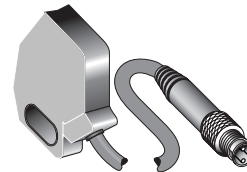
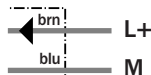

M8, 3-pin

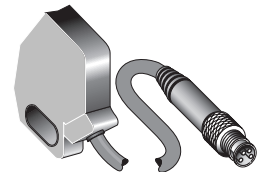
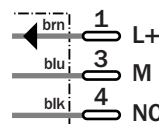

M8, 4-pin

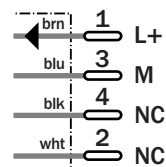

Receiver 3 x 0.09 mm²

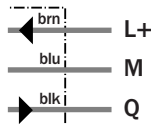

M8, 3-pin

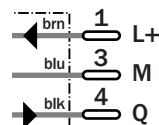

M8, 4-pin

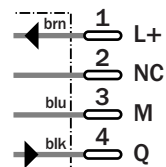

See chapter Accessories

- Connector, M8, 3-pin
- Connector, M8, 4-pin

Technical specifications		WS/WE2F-	E110	F110	F210	F410	N110	P210				
Scanning range typ. max.	0 ... 0.5 m											
Scanning range, recommended	0 ... 0.4 m											
Light source, light type	LED, Red light, 660 nm ¹⁾											
Supply voltage V_s	DC 12 ... 24 V ²⁾											
Ripple	$\leq 5 V_{pp}$ ³⁾											
Power consumption, sender	≤ 10 mA											
Power consumption, receiver	≤ 15 mA ⁴⁾											
Switching outputs	NPN: open collector: Q											
	PNP: open collector: Q											
Switching mode	Dark-switching											
	Light-switching											
Signal voltage PNP HIGH / LOW	$V_s - 1.8$ V / approx. 0 V											
Signal voltage NPN HIGH / LOW	Approx. $V_s / < 1.8$ V											
Output current I_a max	≤ 50 mA											
Response time	≤ 0.5 ms ⁵⁾											
Switching frequency	1,000 Hz ⁶⁾											
Connection type	Cable, PVC, 2 m ⁷⁾											
	Cable with plug, M8, 3-pin, PVC, 200 mm ⁷⁾											
	Cable with plug, M8, 4-pin, PVC, 200 mm ⁷⁾											
VDE protection class	◆											
Circuit protection	V_s connections reverse-polarity protected / In-/outputs short-circuit protected / Outputs overcurrent and short-circuit protected											
Enclosure rating	IP 67											
Ambient temperature operation	-20 °C ... +50 °C											
Ambient temperature storage	-40 °C ... +75 °C											
Weight	Approx. 35 g											
	Approx. 20 g											
Housing material	PC / PBT, PC											

¹⁾ Average service life 100,000 h at $T_a = +25^\circ\text{C}$
²⁾ $\pm 10\%$
³⁾ may not exceed or fall short of
⁴⁾ V_s tolerances without load
⁵⁾ Signal transit time with resistive load
⁶⁾ with light/dark ratio 1:1
⁷⁾ do not bend below 0 °C

Scanning distance and function reserve

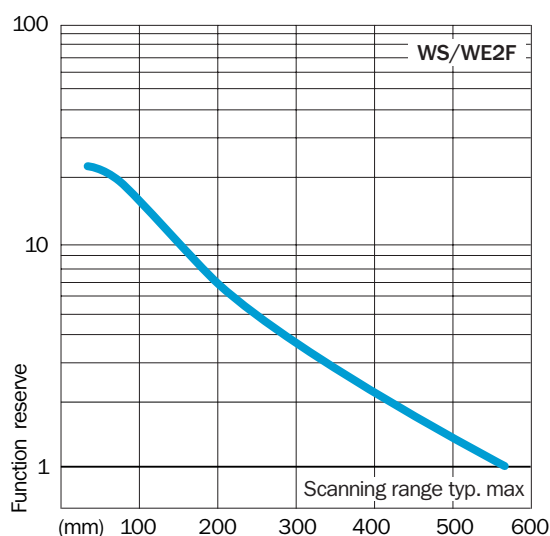
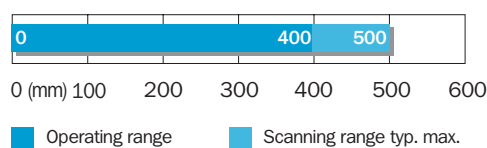

Ordering information

Type	Order no.
WS/WE2F-E110	6 030 554
WS/WE2F-F110	6 030 569
WS/WE2F-F210	6 030 570
WS/WE2F-F410	6 030 571
WS/WE2F-N110	6 030 540
WS/WE2F-P210	6 030 566